



APUS
sports

QUALITY OF TOMORROW



APUS
sports

APUS SPORTS

Apus Sports is a brand of professional fitness accessories which is growing dynamically. Our company is a well tuned team of enthusiasts, athletes, designers and fitness industry experts.

We have grown from a small, Polish based company into a global manufacturer of high quality fitness accessories. Our goal is to design and manufacture professional equipment that will be the pride of your fitness studio and gym, accommodating all budgets. Our equipment will allow you and your clients to develop.



FREE WEIGHTS



DUMBBELL RACK

Dimensions:

L: 250 cm H: 82,5 cm W: 68 cm

Fits 10 pairs

Our Dumbbell Rack has a very modern look and is stylishly finished. Its ergonomic shape and stable base ensure safety and comfort in use. Made from steel and powder coated.



PALLADIUM DUMBBELLS



KG 1 - 10 kg

Palladium Polyurethane Dumbbells feature a permanent one-piece design and are used for strength training in the free weights zone. They can also be used in general development trainings.

The Palladium Dumbbells from Apus Sports combine great functionality and modern design, achieved by the one-piece design and aesthetic solutions. They are ergonomic and have a wide knurling surface, which fits perfectly in every hand.

Polyurethane material ensures lasting durability and high product quality.

DUMBBELL RACK

Dimensions:

L: 73 cm H: 160 cm W: 50 cm

Fits 10 pairs

Our Palladium Dumbbell Rack will do a great job of optimizing space usage in your fitness club. On the one hand, it keeps your accessories tidy and organized, on the other hand, it takes up very little space. Made of high quality powder coated steel, the Palladium Dumbbell Rack is stylishly finished, sturdy and stable.



DUMBBELL RACK

Dimensions:

L: 140 cm H: 78 cm W: 66 cm

Fits 5 pairs

The Dumbbell Rack is made from powder coated steel. It has a stable base for safety when in use. This Dumbbell Rack from Apus Sports has an ergonomic and modern shape.



PALLADIUM DUMBBELLS

KG 2,5 - 25 kg

KG 27,5 - 37,5 kg

KG 40 - 50 kg

Our one-piece Palladium Polyurethane Dumbbells combine excellent ease of use and a modern design. Constructed ergonomically, they feature a large knurled area which makes them fit comfortably in every hand. The polyurethane construction contributes to the long service life and high quality of our dumbbells.

FREE WEIGHTS



TROLLEY FOR BUMPER PLATES

Our Bumper Plate Trolley is a very useful element in the free weights zone and beyond, making it easy to move the plates around with little effort.

Comes equipped with wheels for full mobility. Can be used as a stand for bumper plates and may be used when organizing a training area.



BUMPER PLATES

 5 kg, 10 kg,
15 kg, 20 kg

Our Bumper Plates are made entirely of a compressed granulate which makes them resistant to mechanical damage. Their textured surface facilitates easy lifting from the floor and attaching them to the barbells.

They are perfect for snatch and jerk.



COMPETITION BUMPER PLATES

 5 kg, 10 kg, 15 kg,
20 kg, 25 kg

Apus Sports new Competition Bumper Plates are covered with polyurethane, making them extremely durable. They have olympic colors and an original design. They perfectly complement the equipment in free weight zones or in a functional training area. Thanks to the materials used they are almost indestructible and the polyurethane is odorless.



FREE WEIGHTS



PRE-LOADED BARBELL RACK

Holds maximum 10 barbells

This Pre-loaded Barbell Rack features a stable double-sided construction and is fitted with a chrome rail to support the barbells, ensuring convenient and safe storage.

PRE-LOADED BARBELLS

KG 10-40 kg

10 pieces per set

This type of Pre-loaded Barbell is great for using in a dynamic exercise series, which requires constant changing of weights. With our product you do not need to take the weights off, all you need to do is to change the barbell.

They are made entirely of carbon steel and feature a one-piece construction. The weighted ends covered with polyurethane are permanently attached to the bars which makes our Palladium Barbells sturdy, durable and safe. Their ergonomic design, in respect of construction and surface, contributes to your training comfort.



HEXAGONAL DUMBBELLS

KG 2,5- 25 kg

KG 5- 40 kg

KG 2,5 - 50 kg



Our Hexagonal Dumbbells are made of high quality and durable materials. Rubber coating increase their durability and protect flooring, reducing noise and wear during the training. The ergonomically designed handles are knurled and chrome covered.

FREE WEIGHTS



MERCURY OLYMPIC WEIGHTS

 1,25 kg, 2,5 kg, 5 kg, 10 kg
15 kg, 20 kg, 25 kg

Apus Sports Mercury Olympic weights feature an outstanding ergonomic shape as well as functionality. Covered with premium quality polyurethane, they have specially formed grips and a shape that makes it easier to use.

Thanks to these features they prove their worth both in individual and group workouts. Our weights minimize wrist fatigue when performing trainings with plates only. The weight of the plates are marked with color codes.





CHROME-COATED DUMBBELLS RACK

Fits 10 pairs

Apus Sports Chrome-coated Dumbbell Rack holds up to 10 pairs of dumbbells. It has a durable and stable construction which ensures safety and comfort in the free weight zone and expands the work-out area.



CHROME-COATED DUMBBELLS

 1 - 10 kg

Our Chrome-coated Dumbbells are among the most important pieces of equipment in your gym and in your free weight area. The finish of our Chrome-coated Dumbbells prevents chipping and gives them a great aesthetic look.

The ergonomic design and the knurled grip ensure comfort while you have your workout. The handles provide a non-slip grip. You can use these dumbbells in weight training in the free weight area.

FREE WEIGHTS

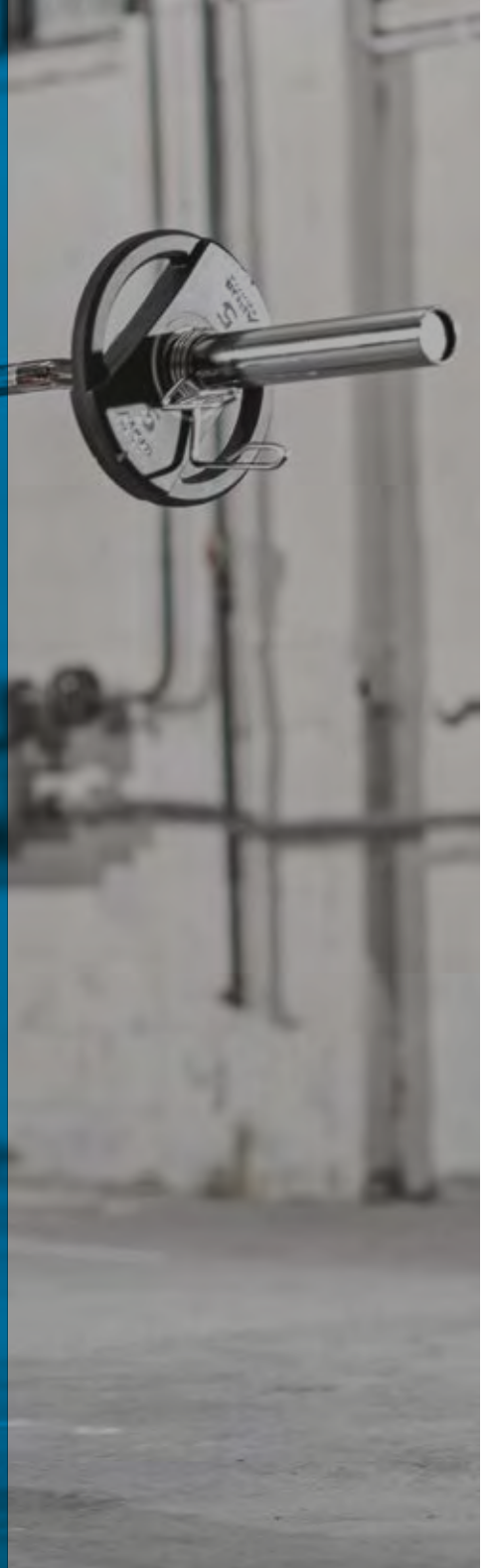

OLYMPIC BARBELL RACK

Dimensions:

L: 101 cm H:140 cm W: 68 cm

Our Olympic Barbell Rack will hold 3 sets of weights and two bars. The height and symmetrical arrangement make the rack very stable and safe.

OLYMPIC BAR



Dimensions:

L: 150 cm  13 kg

L: 180 cm  15 kg

L: 220 cm  20 kg

The Olympic Bar is one of the most important accessories in the free weight zone. This type of equipment is designed for more demanding strength training, and its sturdiness and aesthetics will satisfy even the most demanding users.

The professional Olympic Bar from Apus Sports is made of tempered and chromed steel. The grip covered with a knurling surface guarantees a solid grip during exercise. The product is very strong and made of the highest quality materials.

This piece of equipment should be in every professional gym and fitness club.

Apus Sports Olympic Bar is approved for 450 kg.



ALUMINIUM BAR

Dimensions:

L: 180 cm  10 kg

Our Aluminum Bars are enhancing a gym's design in zones for women. They are lighter and slightly shorter, with different colors - a pink and blue fret.



SPRING BAR CHROMED AND OXIDIZED

Dimensions:

L: 220 cm  20 kg

This professional Chromed and Oxidized Spring Bar is an important part of the free weight zone. Designed for more demanding workouts due to its moving parts and high load capacity.

This product of Apus Sports is made of hard, spring steel. The grip has a knurled surface that guarantees firm contact while training due to the high quality of the needle bearings used. Our bars are extremely durable.

This Apus Sports product is an investment in the highest quality products for the most demanding clients.

Our Spring Bar Chromed and Oxidized is approved for 650 kg.



BAR RACK

Dimensions:

H: 13 cm D: 40 cm  20 kg

Apus Sports Olympic Bar Racks are an important element in free weight zones. They are made entirely of steel, that is why they are stable and durable. Our Bar Racks will hold 8 bars. They are available in black and silver.

FREE WEIGHTS

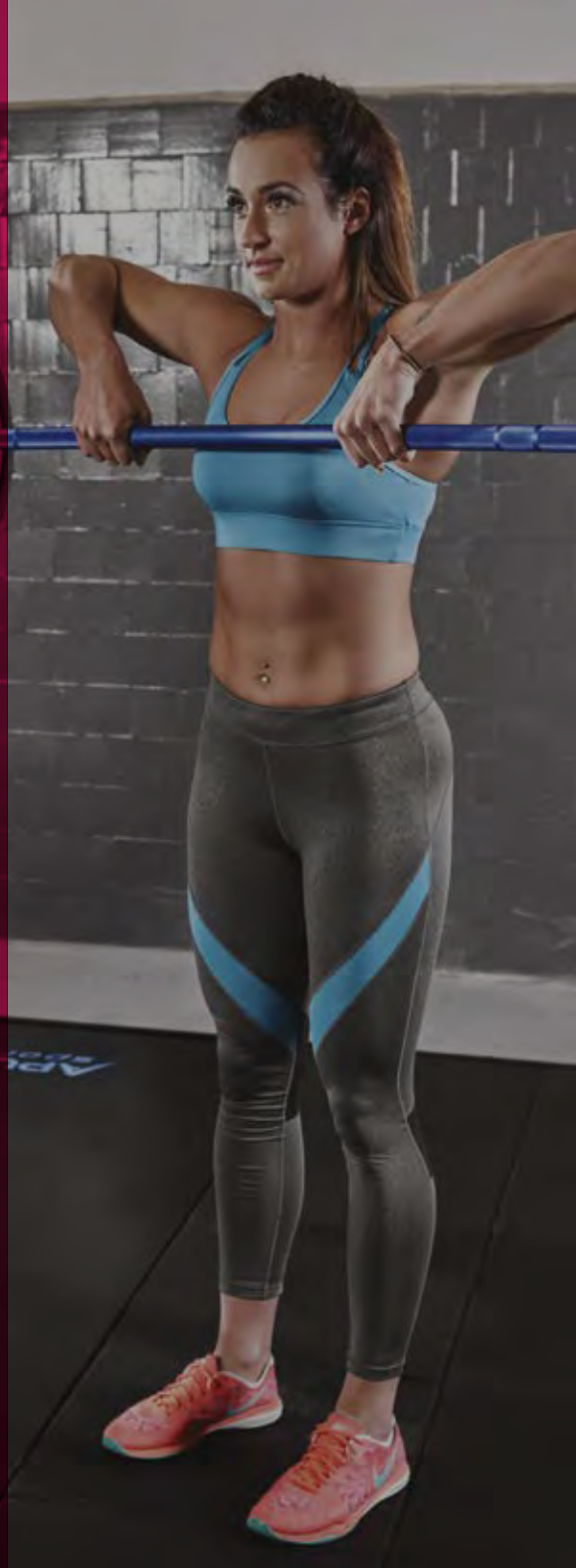

T-BAR HOLDER

Our T-Bar Holders allow you to use bars in various weight training exercises and other activities.

This holder is designed for bars with both small and large diameters. It incorporates two bolts that stabilize the bar during your workout.





CURL BAR

Dimensions:

L: 120 cm



9 kg

Our Curl Bar will perform very well both in your home workout space and in a professional gym. The Curl Bar has a knurled surface that provides a secure and firm grip. The revolving sleeve, made of hardened steel, makes the bar extremely resistant to cracking.



OLYMPIC SUPER CURL BAR

Dimensions:

L: 120 cm



9 kg

Apus Sports Olympic Super Curl Bar is made of chromed steel and you can perform multiple exercises of the upper body.

Our bar is certainly one of the primary components of the free weight area.



WEIGHT LIFTING PLATFORM

Dimensions:

3 m x 3 m x 3 cm

This Apus Sports product is made of durable plywood (the middle section) and rubber materials surrounding it. The construction has a sturdy steel frame.



FREE WEIGHTS

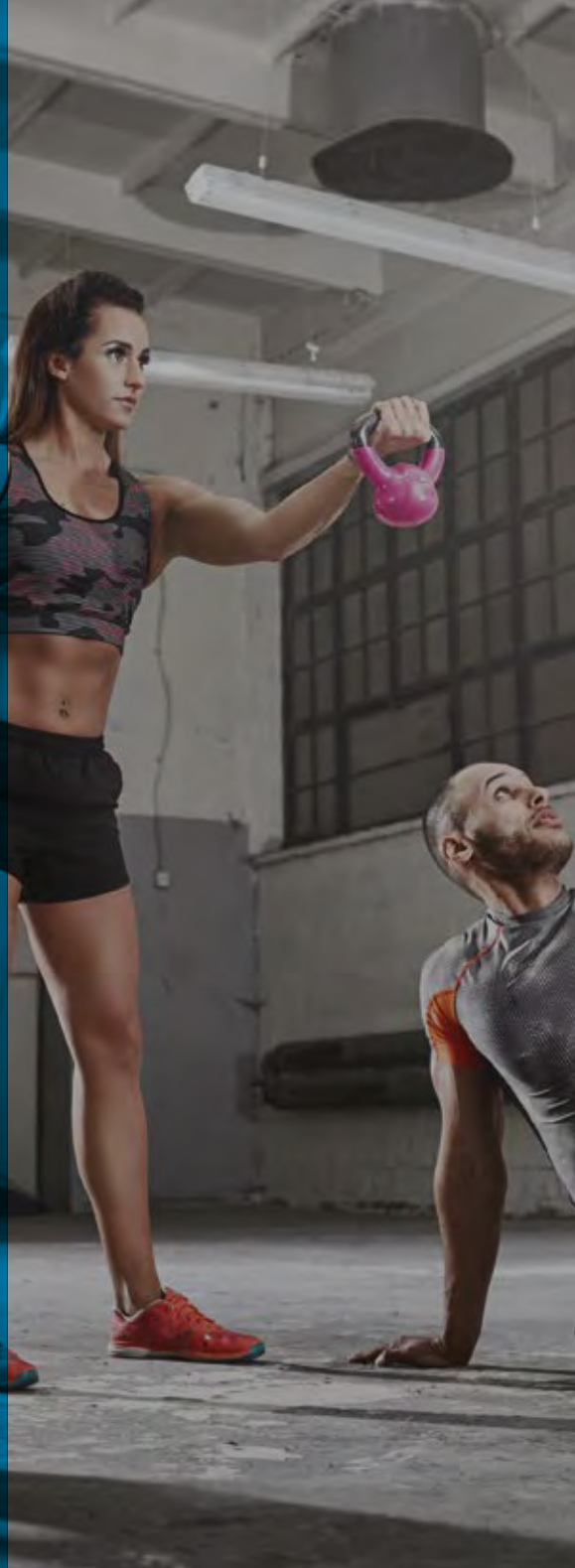

KETTLEBELL RACK

Dimensions:

L: 120 cm H: 56 cm W: 50 cm

Our spacious two-tier designed rack will easily accommodate your kettlebell set. The shelves provide easy access.



KETTLEBELL



4 kg, 6 kg, 8 kg, 10 kg
12 kg, 16 kg, 20 kg

Our new Kettlebells stand out thanks to their ergonomic shape and optimum handle size. Their vinyl finish makes them more resistant to mechanical damage and easier to clean.



STEEL KETTLEBELL



8 kg, 12 kg, 16 kg, 20 kg, 24 kg,
28 kg, 32 kg, 36kg

All competition Kettlebells are made of steel which are of the same size regardless of their weight. They are made of premium quality materials.

Their flat bottom increases stability while the color codes allow you to quickly find the weight you are looking for.



DESIGN AND TECHNOLOGY

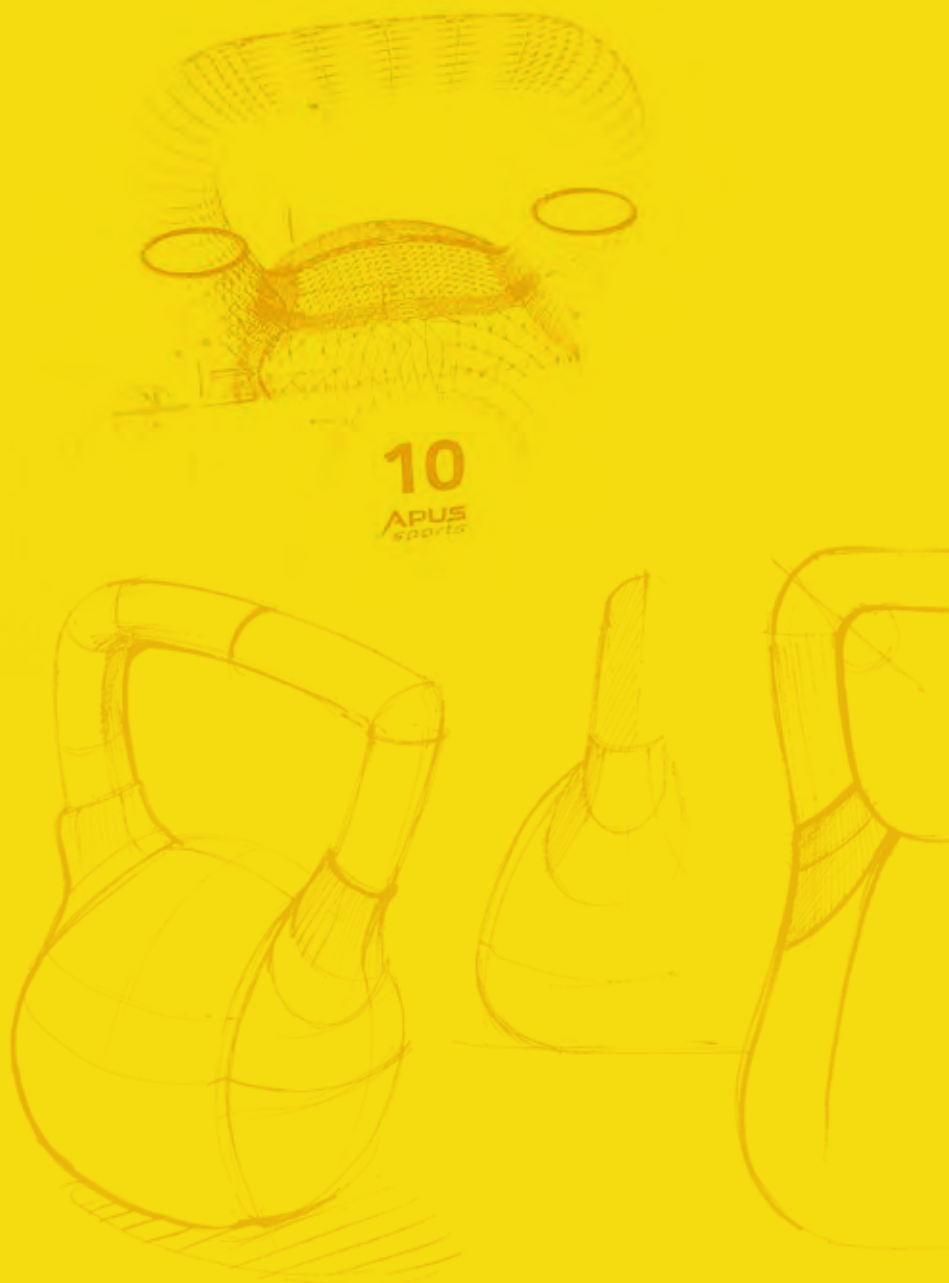

EXCEPTIONAL EQUIPMENT JUST FOR YOU

The unique design of equipment from Apus Sports and the highest quality materials define a new standard in the fitness industry. The excellence of the workmanship and precision in production ensures that these items will complement any fitness club and will benefit their members.

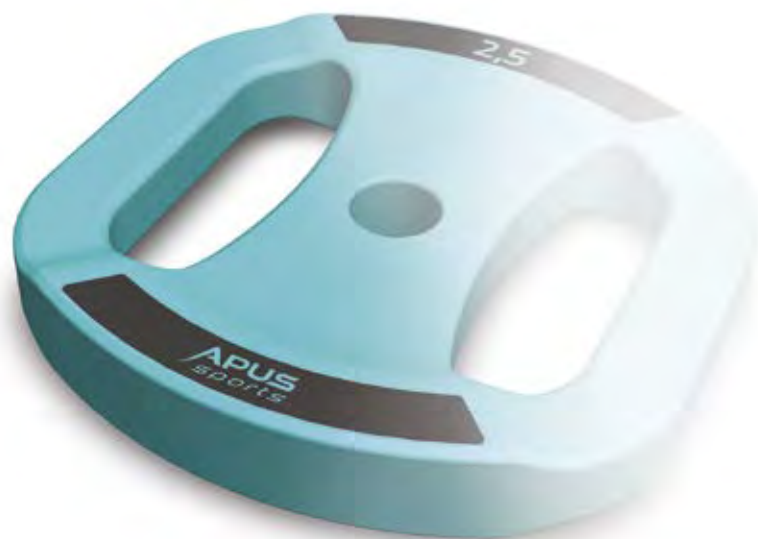

UNIQUE DESIGN

Apus Sports has created a variety of unique and original products in collaboration with a professional design studio and their creative team of top designers.

Our Apus Sports products are made of the highest quality materials for maximum performance, durability and ergonomics.

Designing accessories is a process consisting of market research in the field of ergonomics and user preferences, as well as a detailed technical analysis of the optimal materials needed. The models created are then tested and refined ensuring the final product is of the highest quality.



HIGH QUALITY MATERIALS

Polyurethane is among the modern materials used in our accessories as. It is very durable, odorless and has vast design, shape and color potentials.

Our polyurethane accessories leave no marks on the floor even after long term use. They maintain their original form and color which outperforms other brands.

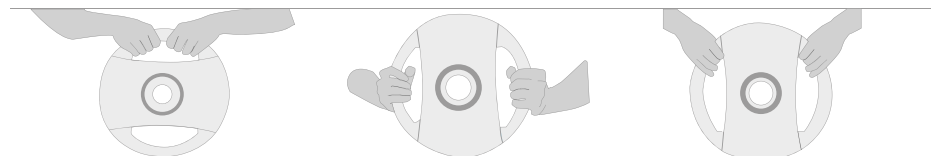

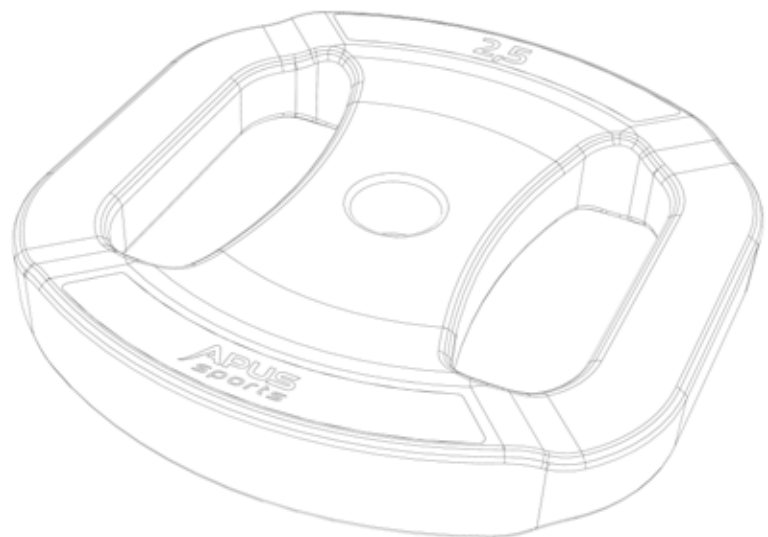
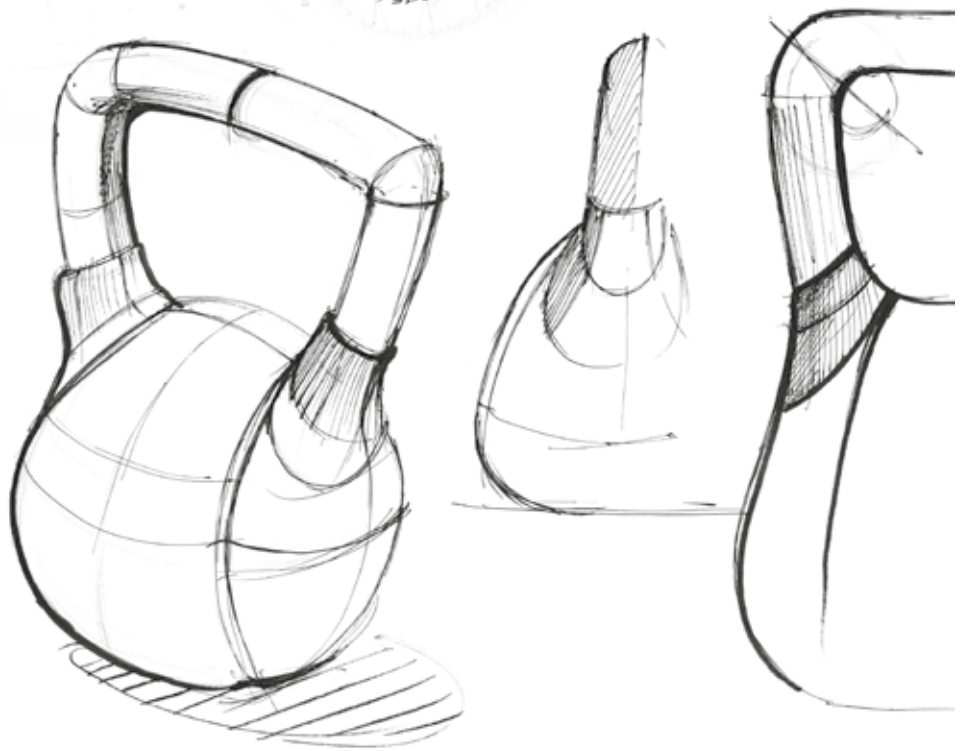
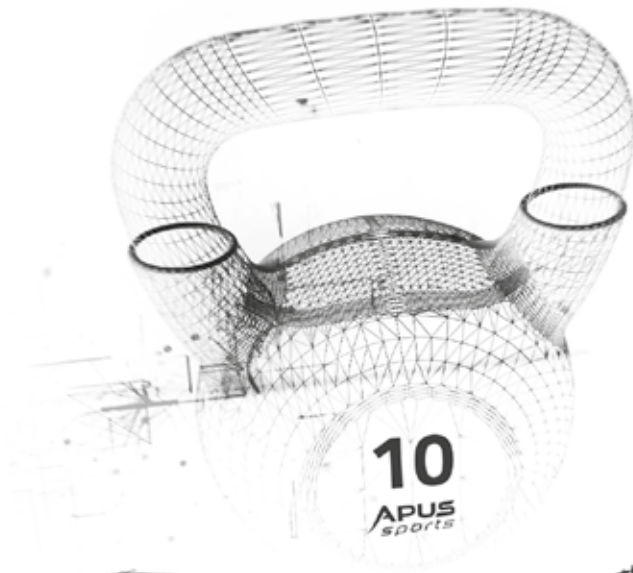

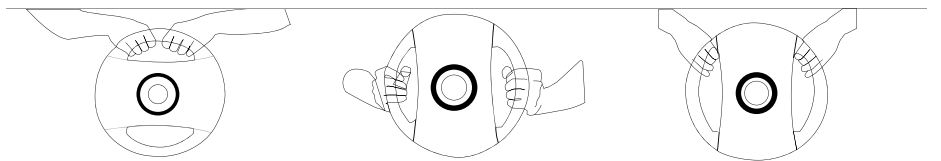
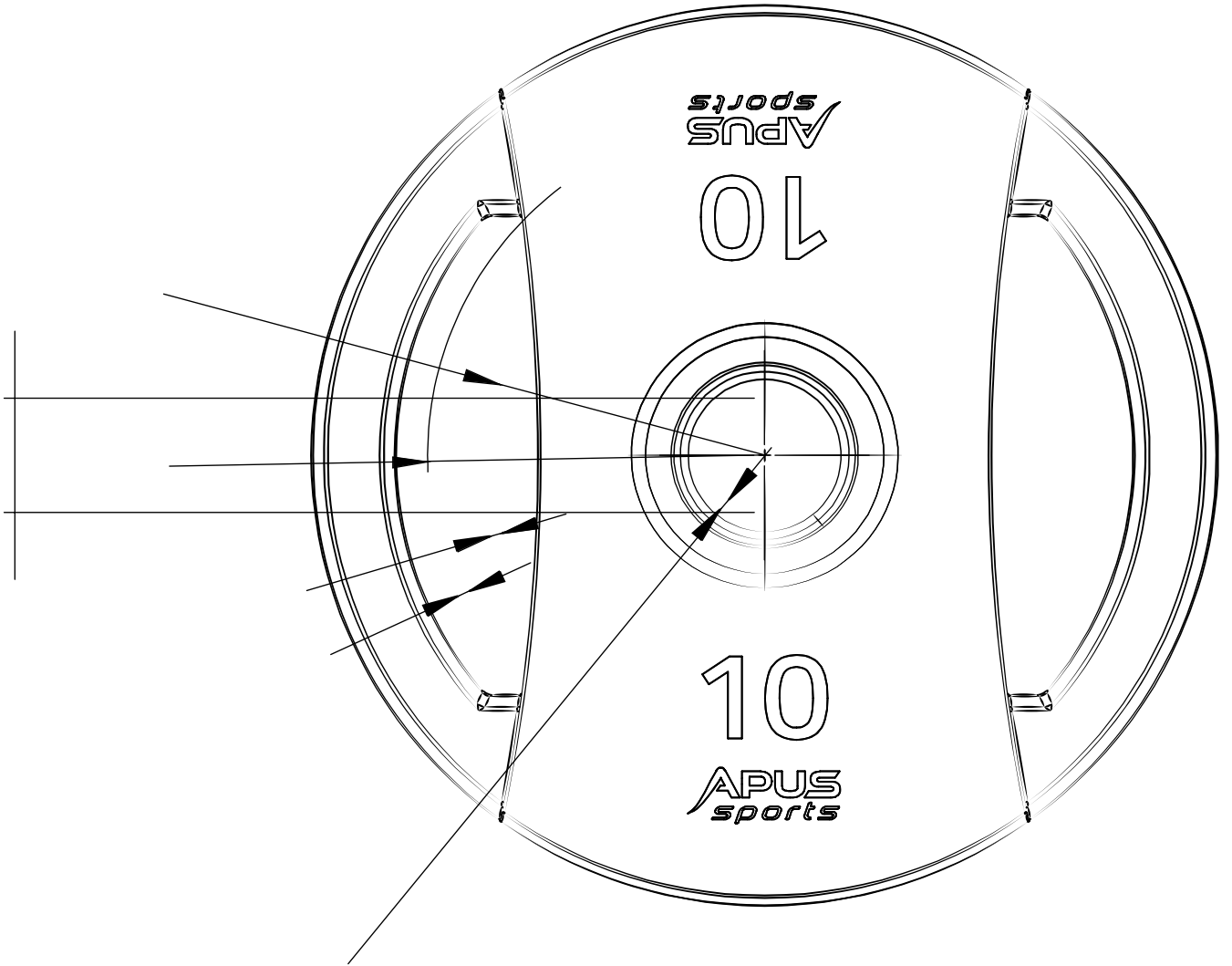

FUNCTIONAL TRAINING



MEDICINE / SLAM BALLS RACK

Dimensions:

L: 42 cm H: 165 cm W: 55 cm

Apus Sports Universal Rack for Medicine Balls and Slam Balls features a well-balanced design and accommodates 5 balls.



MEDICINE BALLS

 2 kg, 3 kg, 4 kg, 5 kg, 6 kg,
7 kg, 8 kg, 9 kg, 10 kg

Our Medicine Balls feature a varied surface and a special concave texture. This resembles a honeycomb for improved gripping action when throwing and catching the ball during dynamic training.

The clear weight markings are consistent with the color codes used for free weights, allowing you to quickly identify the proper medicine ball. Our products are made of premium quality rubber ensuring longevity and resistance to damage.



OVERSIZED MEDICINE BALLS

 4 kg, 6 kg,
8 kg, 10 kg

Oversized Medicine Balls are essential products for rehabilitation programs. They are also used in body conditioning and functional trainings.

These balls are made of exceptionally strong leather and sewn with a durable thread which makes the ball resistant to deformation. The clear weight markings on the balls are consistent with the color codes used for free weights, allowing you to quickly identify the correct Medicine Balls.



SLAM BALLS

 3 kg, 5 kg, 7 kg, 9 kg, 12 kg,
15 kg, 18 kg, 20 kg

Our re-launched Slam Balls feature clear weight markings, consistent with the weight labelling on our other products.

Their textured surface, with a pattern resembling a honeycomb, as well as an optimum diameter ensures a firm grip during exercises. Slam Balls are made of a premium quality rubber, featuring outstanding resistance to any damage.



FUNCTIONAL TRAINING



UNIVERSAL BALL AND FIT BAG RACK

Dimensions:

L: 75 cm H: 174 cm W: 54 cm

This Universal Rack from Apus Sports will hold fit bags, medicine balls and slamballs.

A balanced and well designed product which helps keep your gym space well organized.

FIT BAG

 5 kg, 10 kg, 15 kg,
20 kg, 25 kg

Apus Sports Fit Bags come equipped with additional ergonomic handles, allowing you to perform a significantly wider range of exercises. Noteworthy advantages include a reinforced construction and sturdy straps.

Weight markings are consistent with other Apus Sports products.



BATTLE ROPE

Dimensions:

L: 10 m  10 kg

Our Battle Rope exercises all your muscles, it is a great way to burn calories and increase your endurance. Our ropes are made of 100% high quality nylon, the ends are protected against fraying.

The length of the rope can easily be adjusted to suit your needs and the amount of training space available to you.



FUNCTIONAL TRAINING JUMP ROPE

Dimensions:

L: 3 m  0,15 kg

Our Jump Rope features an adjustment option, allowing you to adjust the length to your height. With its ample functionality this jump rope will work great in every gym.

The built-in bearings connected to the upper part of the handles prevent the rope from twisting.



TRAINING BELT

Sizes:

M L XL

Apus Sports Training Belts are used to reduce the risk of injury during training with a heavy load. Double stitching and high quality leather guarantee longer life; the belt can be adjusted to customize it to the user's needs.



FUNCTIONAL TRAINING



TRAINING HAMMER

 4 kg, 6 kg,
8 kg, 10 kg

Apus Sports Training Hammers, cast in one piece, have a knurled surface providing a better grip during your workout. Training Hammers are often used to complement a tire workout. They are great for improving strength and developing an athletic physique.





WOODEN GYMNASTIC RINGS



Our Wooden Gymnastic Rings will work well for all types of suspension trainings. Their durability and slip resistance ensures precise movements.

They are a universal piece of equipment that every gym should have. Using one's own body weight this product may be used in: gymnastics, isometric exercises and in functional training.

10 KG WEIGHTED VEST

Apus Sports 10 kg Weighted Vest is a high quality and durable product designed to provide the ultimate training experience. Our Weighted Vest is universal in size and has Velcro straps that adjust to fit any torso.

Thanks to the weights distributed across the chest and the back our vest offers free range of motion for dynamic resistance training.



PLYOBOX

Dimensions:

50 cm x 60 cm x 75 cm

Our Plyobox is made of premium quality plywood that is durable and has a non-slip surface. It is relatively light and easy to carry. The surface of our Plyobox provides a stable landing area.

You can flip your Plyobox onto any side, adjusting the height according to the level of difficulty needed in training.



FUNCTIONAL TRAINING



MINI POWER BANDS

Mini Power Bands are the perfect tool for mobility training and stretching.

Due to their size and shape, they are suitable for: warm-ups, rehabilitation and activation exercises, as well as for intensifying exercises on individual muscles.

Our range includes several types of loops which are categorized and marked by colors according to resistance level:

Pink: 6,8 kg

Blue: 9 kg

Green: 11,3 kg

Yellow: 13,5 kg

MULTIFUNCTIONAL RACK

Dimensions:

L: 320 cm H: 220 cm W: 60 cm

Apus Sports Multifunctional Rack can replace several different stands for fit bags, slam balls, medicine balls and other our products.

Thanks to the modular structure of our rack, it can be easily built to suit the club's zone. The accessories can be stored in a fitness room or in functional training areas. Our Multifunctional Rack creates more training space and keeps your facility orderly and safe.



POWER BANDS

Our Power Bands which are made from high quality latex, feature outstanding strength. Thanks to their optimum size, they are easy to store and clean.

This universal and compact piece of equipment will surely be useful in every gym and fitness club. Our range includes several types of loops which are categorized and marked by colors according to resistance level:

- Pink: 3-11 kg
- Blue: 5-18 kg
- Green: 15-25 kg
- Yellow: 32-43 kg
- Orange: 40-50 kg
- Purple: up to 100 kg



FITNESS ZONE



STEP

Apus Sports Step is perfect for strengthening, cardio and mixed training. It features a three position height adjustment and has a non-slip surface that even when wet ensures safety during exercise. It is lightweight and durable.

Available in two attractive colors: pink and blue.





ROLLER GRID

Dimensions:

L: 33 cm

Apus Sports sturdy Roller Grids, made of foamed PVC, are hard and stable and do not absorb moisture or sweat. They do not deform from extended use. They are light, take up little space and are suitable as a self-massaging tool, both for professional and amateur athletes.

Our Roller Grids help your muscles regenerate quicker and relax your body after exercising. They can also be used in training for increased flexibility.



ROLLER

Dimensions:

L: 45 cm, 90 cm

Our Roller is perfect for exercises increasing your muscle flexibility. The foam coating does not absorb moisture and is resistant to deformation. The optimal length of the roller ensures that all your muscle groups are well exercised.



GYMNASTIC BALLS

Dimensions:

55 cm, 65 cm, 75 cm

Apus Sports Gymnastic Balls, made of anti-burst, foamed PVC, are resistant to deformation and their profiled, non-slip surface ensures a stable position during exercise.



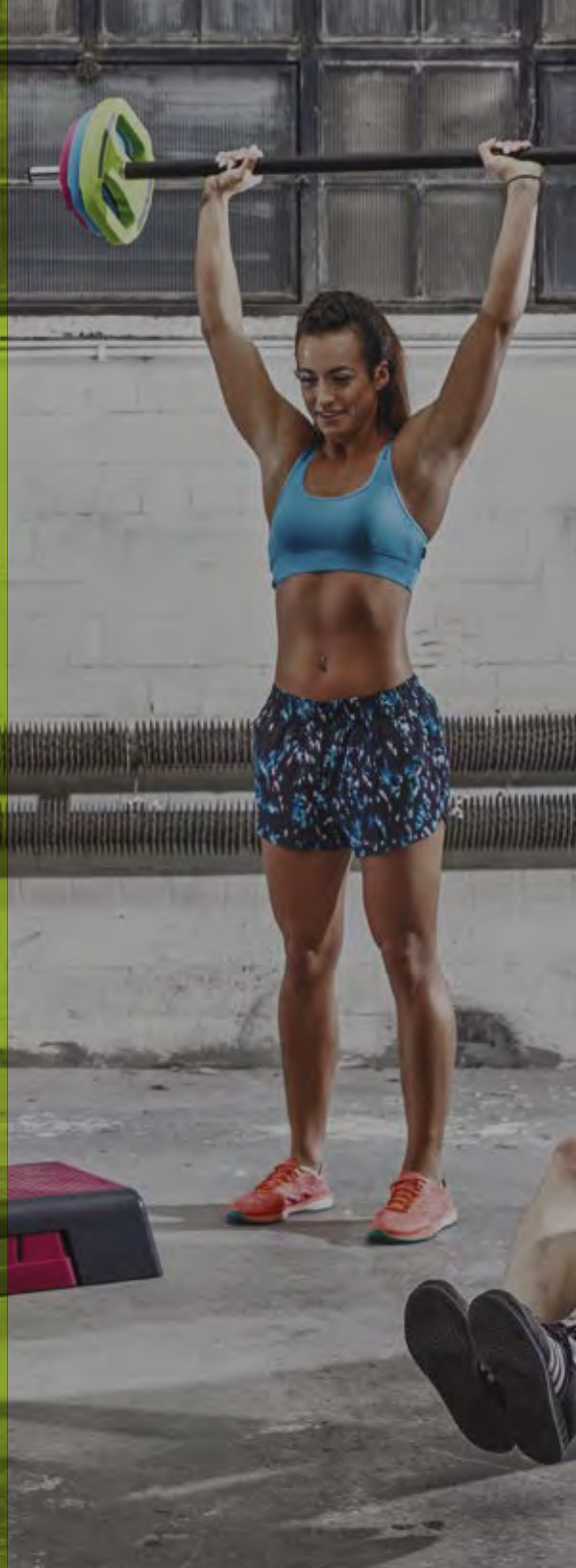

SPACE BAR SET RACK

10 and 20 piece sets

Dimensions:

L: 72 cm H: 176 cm W: 84 cm

L: 73 cm H: 180 cm W: 135 cm

Our Space Bar Set Rack allows you to keep your accessories tidy and organized in your gym or fitness club. Its ergonomic design makes it easy to replace and lift the weights.

The rack features a collar box and a separate area for bars. We offer two rack versions for multiple-piece sets.



HELIUM VINYL DUMBBELLS

 0,5 kg, 1 kg, 1,5 kg,
2 kg, 2,5 kg, 3 kg, 4 kg

Our ergonomically shaped Helium Vinyl Dumbbells feature handles designed especially for women's hands. Made of cast iron, they are covered with a vinyl coating.

These dumbbells are a fantastic, colorful addition in all gyms, expanding the variety of equipment available. They improve the women's zone, the free weight area and are excellent products for warm-up routines.

Please note: dumbbells are sold in pairs.



SPACE BAR

 1,25 kg, 2,5 kg, 5 kg

Apus Sports ergonomically designed Space Bar, made of polyurethane, is a "must have" in gyms for group and individual exercises.

They are easy to store thanks to the purposefully designed shape. Our Space Bars have a colorful, easy to clean surface.

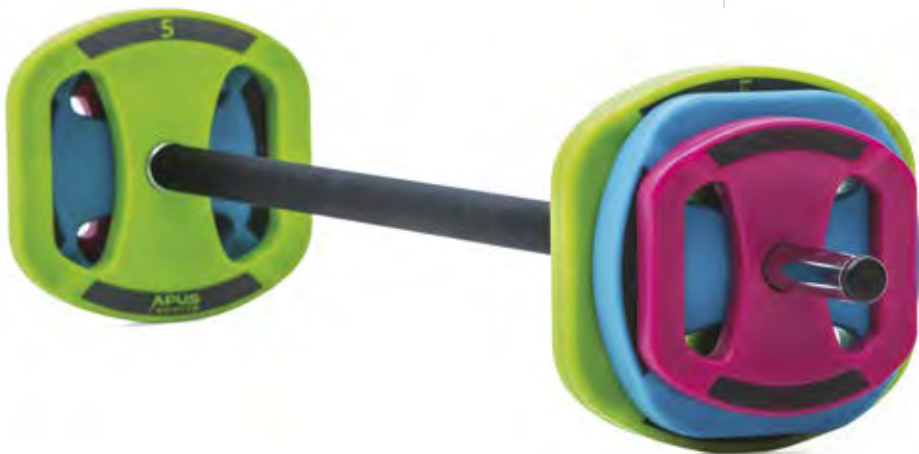



LONG FITNESS MAT

Dimensions:

143 cm x 60 cm x 1 cm

This is a non-slip Long Fitness Mat for Pilates and Yoga. Made from wear-resistant and easy-to-clean material, it features a durable coating that ensures a good grip during exercise.

An additional advantage of our product are the sturdy grommets that facilitate safe and hygienic storage.





SHORT FITNESS MAT

Dimensions:

100 cm x 50 cm x 0,9 cm

Apus Sports Short Fitness Mats feature a specially designed non-slip underside that is resistant to abrasion. An additional advantage of our product are the sturdy grommets that facilitate safe and hygienic storage.



MAT HANGER

Dimensions:

61 cm x 7 cm

The Apus Sports Mat Hanger helps organize fitness areas throughout the gym where needed.

FITNESS ZONE



TUBING STEP STRAPS

Dimension:
L: 160 cm

Apus Sports Tubing Step Straps are an excellent accessory when exercising, because it has a tape designed to secure under our step. The tubing is made out of rubber and our straps have ergonomic handles ensuring comfort in use.



light

strong

medium



TUBING BASIC

Dimension:

L: 122 cm

Tubing Basic exercises are perfect when you want to work with small weights. Our Tubing is made out of rubber and our straps have ergonomic handles ensuring comfort in use.



BALANCE STEP

Apus Sports Balance Step is a piece of equipment suitable for various types of enhancing, agility and balance training. It features a non-slip rubber-coated, flat surface on one side and a balloon made of anti-burst, foamed PVC on the other side.

Our Balance Steps are solid, each set comes with two tubing straps.







Total Fitness Concept Sp. z o.o. Sp. k.

Rybitwy 2, 30-722 Cracow, Poland

+48 12 684 33 92

biuro@tfc-global.com

www.apus-sports.com